

Catálogo Varejo

AROUCA[®]
FECHADURAS



tradição & evolução





Intertek



**ASSOCIAÇÃO
BRASILEIRA
DE NORMAS
TÉCNICAS**

Produtos produzidos de acordo
com a NBR 14913

**EMPRESA
100%
NACIONAL**



Premium
Zamac
Qualidade 100% garantida

INOX *304
Premium*
Super resistente a corrosão



LANÇAMENTOS.....	04
ECOLINE.....	13
ROSE GOLD.....	14
BLACK.....	16
CHALLENGER.....	19
BLIM BLIM.....	22
VERONA.....	23
NYLON.....	30
ELEGANT.....	31
COLONIAL.....	34
ABITARE.....	35
TRINCO ROLETE.....	36
PUXADORES.....	38
SERRALHERIA E MARCENARIA.....	40
AUXILIAR.....	48
ACESSÓRIOS.....	52
AVULSOS.....	54
MOSTRUÁRIOS.....	56

Lançamentos

A primeira fechadura digital do Brasil que atende a norma ABNT NBR 14.913



código: digi 55

- Maçaneta Inteligente digi;
- Roseta redonda;
- Máquina normatizada arouca 4010/55;
- Distância de broca: 55mm;

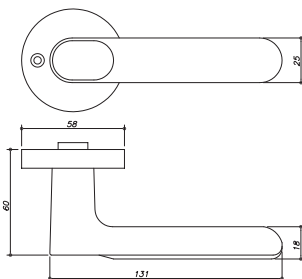

Leitura Biométrica



Trava inteligente e instantânea



Cadastro de até 20 usuários

Lançamentos



Chega de pilhas!

Você pode usar qualquer dispositivo de carregamento micro USB para recarregar a sua digi. Fique tranquilo, ela conta com uma bateria de longa duração e emite avisos quando necessita de recarga.



Sensor biométrico de alta velocidade, com capacidade para cadastro de até 20 usuários diferentes.



Carregamento via **USB**
e aviso de bateria fraca



Atende os requisitos
da norma **NBR 14.913**



Fácil instalação

Lançamentos

PUXEPÉ é o puxador de portas com os pés, pise e puxe. Além de prático e simples de instalar, esse produto evita o contato das mãos com superfícies contaminadas



BL PU777- INOX

Material: Aço Inox 304

Aplicação: Portas de Madeira

«PUXEPÉ

PUXADOR PISE E PUXE

BL PU888V

Material: Polímero

Aplicação: **Porta de vidro**

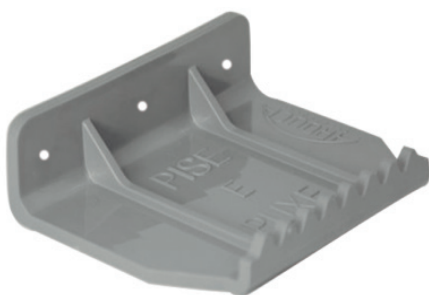

BL PU888

Material: Polímero

Aplicação: **Porta de madeira**

Novidade! **KIKO**



KIKO
10.80.587-Z-ZC
Máquina de 40 e 55 mm

ZCE
ZBT



Novidade! **SOFIA**



SOFIA
10.80.585-Z-ZC
Máquina de 40 e 55 mm

ZCE
ZBT



Lançamento 2021

DELTA



DELTA

10.86.589-Z-ZC

Máquina de 55 mm

Acabamentos disponíveis: ZC/ ZCE/ ZBT e ZEP

Lançamento 2021

FLAT



Mais conforto para você!
Acabamento abaulado no verso



FLAT

10.80.588-Z-ZC

Máquina de 55 mm

Acabamentos disponíveis: ZC/ ZCE/ ZBT e ZEP

QUATTRO
FECHADURAS AROUCA DE ALTA SEGURANÇA

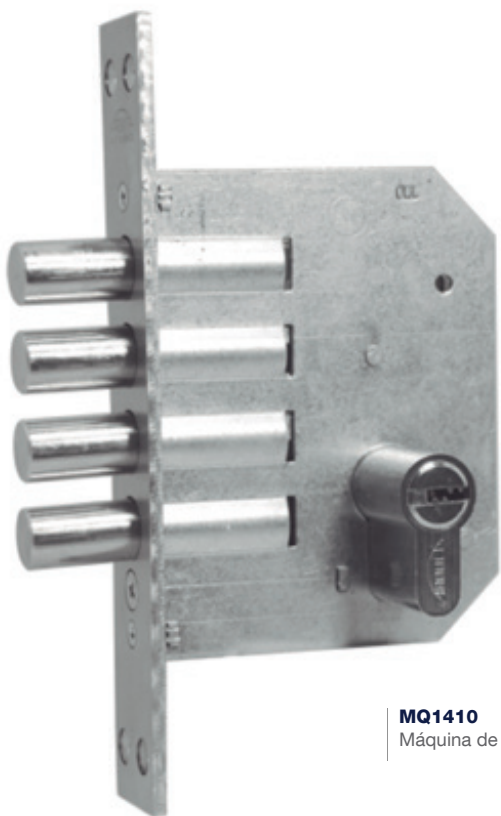

MQ1410

Máquina de 55 mm

- Máquina Arouca de alta segurança, reforçada com 55mm de distância de broca;

- 04 pinos de aço giratórios, super reforçados e resistentes, dificultando o arrombamento;

- Chapa testa em inox com 3mm de espessura;

QUATTRO

FECHADURAS AROUCA DE ALTA SEGURANÇA



Dicas: Na linha Quattro, você compra os itens avulsos (Rosetas, Cilindros e Máquinas) e monta o conjunto do seu jeito

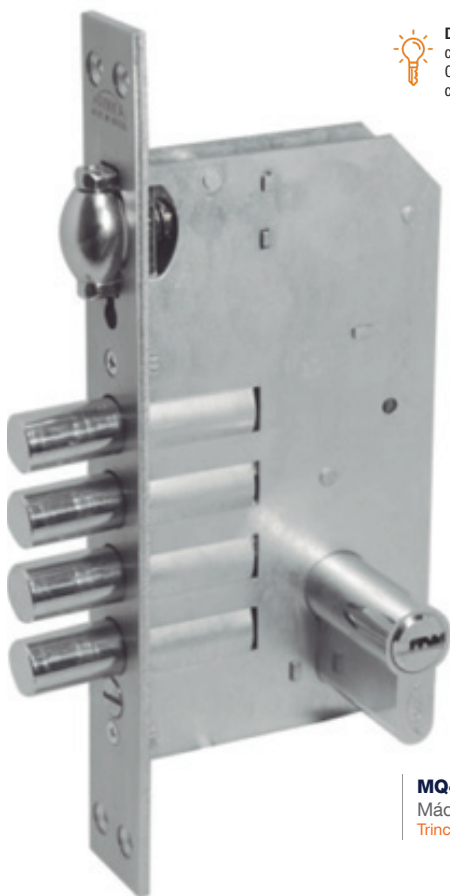

MQ4410TR

Máquina de 55mm
Trinco rolete regulável

- Cilindro multiponto europerfil de latão com 06 pinos, de 60mm a 120mm;

- Acompanha 05 chaves multiponto de latão, dificultando a ação de micha;

QUATTRO

FECHADURAS AROUCA DE ALTA SEGURANÇA

Cilindro multiponto
europerfil de latão com
06 pinos, de 60mm a
120mm.



CILINDRO EUROPERFIL

Acabamento: LC

CÓDIGO	COMPRIMENTO	ESPESSURA DA PORTA
CL3060-LC	60MM	35mm a 45mm
CL3080-LC	80MM	até 65mm
CL3100-LC	100MM	até 85mm
CL3120-LC	120MM	até 105mm

Rosetas com
furo europerfil



KRO098/EURO

Acabamentos disponíveis: IE



KRO086/EURO

Acabamentos disponíveis: IE



Indicadas para
áreas litorâneas



ELLE

10.86.592-Z-IE
Máquina de 55 mm

IP 



BRAVA

10.86.593-Z-IE
Máquina de 55 mm

IP 



QUADRA

10.98.594-Z-IE
Máquina de 55 mm

IP 

DOBRADIÇA 398A

Tamanho	Acabamento
3" x 2 1/2"	IP (Polido) ou IE (Escovado)
3 1/2" x 3	IP (Polido) ou IE (Escovado)



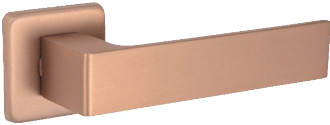

CHESS

10.80.84-Z-ZCOE

Máquina de 55 mm

Acabamentos disponíveis: ZC/ZCE/ZBT e ZEP

ARC

10.86.546-Z-ZCOE

Máquina de 55 mm

Acabamentos disponíveis: ZC/ZCE/ZBT e ZEP



CHEVRON

10.98.508-Z-ZCOE

Máquina de 55 mm

Acabamentos disponíveis: ZC/ZCE/ZBT e ZEP



Fechadura Auxiliar - 03 PINOS

1310-Z-ICOE

Máquina 45 mm

Disponível com roseta redonda (086) ou quadrada (098)

Trinco Rolete - 03 PINOS

4310TR-Z-ICOE

Máquina 55 mm

Disponível com roseta redonda (086) ou quadrada (098)



Bico Duplo

1006-Z-ICOE

Máquina 45 mm

Disponível com roseta redonda (086) ou quadrada (098)



Nova fixação
com parafuso allen



CHEVRON

10.98.508-Z-ZEP

Máquina de 55 mm

Acabamentos disponíveis: ZC/ZCE e ZCOE

CHESS

10.80.84-Z-ZEP

Máquina de 40 e 55 mm

Acabamentos disponíveis: ZC/ZCE/ZBT e ZCOE



METROPLANA

10.80.581-Z-ZEP

Máquina de 55 mm

Acabamentos disponíveis: ZC/ZCE e ZBT



STILO

10.80.27-Z-ZEP

Máquina de 55 mm

Acabamentos disponíveis: ZC/ZCE e ZBT

BLACK



ARC

10.86.546-Z-ZEP

Máquina de 55 mm

Acabamentos disponíveis: ZC/ZCE e ZCOE

LANDAU

10.84.83-Z-ZEP

Máquina de 40 e 55 mm

Acabamentos disponíveis: ZC/ZCE e ZBT



RETA

10.84.34-Z-ZEP

Máquina de 55 mm

Acabamentos disponíveis: ZC/ZCE e ZBT



BICO DUPLO

1006-Z-IEP

Distância de broca de 45mm

Disponível com roseta redonda (086) ou quadrada (098)

TRINCO ROLETE - 03 PINOS

4310TR-Z-IEP

Máquina de 40 e 55 mm

Disponível com roseta redonda (086) ou quadrada (098)



TRINCO ROLETE

4110TR-Z-IEP

Máquina de 45 mm

Challenger



COLUMBIA
10.61.553.Z-ZC
Máquina de 55 mm



ZCE



ZBT

Disponível nas opções
⊕ Tetra e Trifecha



Disponível nas opções
⊕ Tetra e Trifecha



COLUMBIA
10.81.553-Z-ZC
Máquina de 55 mm

ZCE



ZBT



Challenger

Nova fixação
com parafuso allen



Maçaneta **maciça**



QUINZE
10.86.515-Z-ZC
Máquina de 55 mm

ZCE



ZBT



HEBE
10.95.542-Z-ZC/ZCE
Máquina de 55mm

Disponível nas opções
Tetra e Trifecha



ZBT



HEBE
10.63.542-Z-ZC/ZCE
Máquina 55 mm

Disponível nas opções
Tetra e Trifecha



ZBT



Challenger

KANSAS

10.56.557-Z-ZC
Máquina de 55 mm



ZCE



ZBT



KANSAS

10.81.557-Z-ZC
Máquina de 55 mm

ZCE



ZBT



DENVER

10.81.554-Z-ZC
Máquina de 55 mm

ZCE



ZBT



Disponível nas opções

 Tetra e Trifecha

Blim Blim

Para portas de 35 à 45mm

7 cm



650 - ZBT

40,5 cm



650 - ZC



650 - ZCE



660 - ZLP



CHESS
10.80.84-Z-ZC
Máquina de 40 e 55 mm

ZCE

ZBT



LANDAU
10.84.83-Z-ZC
Máquina de 40mm

ZCE

ZBT





METROPLANA
10.80.581-Z-ZC
Máquina de 40 e 55 mm

ZCE



ZBT



PLANA I
10.80.80-Z-ZC
Máquina de 40 e 55 mm

ZCE



ZBT



PLANA II
10.80.79-Z-ZC
Máquina de 40 e 55 mm

ZCE



ZBT



QUADRA Z
10.80.44-Z-ZC
Máquina de 40 e 55 mm

ZCE



ZBT



Verona



STILO

10.80.27-Z-ZC
Máquina de 40 e 55 mm

ZCE



ZBT



Disponível nas opções

 Tetra e Trifecha

UNA Z

10.26.17-Z-ZBT
Máquina de 40 e 55 mm



ZC



ZCE



Disponível nas opções

 Tetra e Trifecha
com rosetas redondas ou quadradas



UNA Z

10.84.17-Z-ZC
Máquina de 40 e 55 mm

ZCE



ZBT





FLY Z
10.84.10-Z-ZC
Máquina de 40 e 55 mm



POLO Z
10.94.29-Z-ZC/EB
Máquina 55 mm



POLO Z
10.84.29-Z-ZC
Máquina de 40 e 55 mm



LINEA
10.84.59-Z-ZC
Máquina de 40 e 55 mm





Disponível nas opções

 Tetra e Trifecha



VICTORIA

10.84.49-Z-ZC

Máquina de 40 e 55 mm

ZCE



ZBT



IDEA

10.84.75-Z-ZC

Máquina de 40 e 55 mm

ZCE



ZBT



UP

10.84.39-Z-ZC

Máquina de 40 mm

ZCE



ZBT



GOLF Z

10.84.18-Z-ZC

Máquina de 40 e 55 mm

ZCE



ZBT





OVO Z

10.84.19-Z-ZC

Máquina de 40 e 55 mm

ZCE

ZBT



OVO Z

10.27.19-Z-ZC

Máquina de 40 e 55 mm



ZCE

ZBT



OVO Z

10.57.19-Z-ZC

Máquina de 40 e 55 mm

ZCE

ZBT



Verona



TEXAS

10.81.62-Z-ZC
Máquina de 40 e 55 mm

ZCE



ZBT



ROMANA

10.80.35-Z-ZC
Máquina de 40 e 55 mm

ZCE



ZBT



RETA

10.84.34-Z-ZC
Máquina de 40 e 55 mm

ZCE





Indicadas para
áreas litorâneas



POLO
10.88.529-Z-NP
Máquina 55 mm

POLO
10.61.529-Z-NP
Máquina de 40 e 55 mm



ECCO
10.90.39-Z-NP
Máquina de 40 e 55 mm

MARTE
10.61.521-Z-NP
Máquina 55 mm



Elegant



SLIM

10.84.25-Z-ZBT
Máquina de 40 e 55 mm

ZC



SLIM

10.26.25-Z-ZC
Máquina de 40 e 55 mm



ZBT





GOL

10.56.36-Z-ZC

Máquina 45 mm e 55 mm

Acabamentos disponíveis:

ZC/ZBT/ZEP

*Disponível com maçaneta Fixa (FX)



GOL

10.25.36-Z-ZBT

Máquina 45 mm e 55 mm

Acabamentos disponíveis:

ZC/ZBT/ZEP

*Disponível com maçaneta Fixa (FX)

DUE

10.25.00-Z-ZC

Máquina 45 mm e 55 mm

Acabamentos disponíveis:
ZC e ZEP

*Disponível com maçaneta Fixa (FX)



ZEP



DUE

10.84.00-Z-ZC

Máquina 45 mm e 55 mm

ZEP



ZBT



*Disponível com maçaneta Fixa (FX)



SATURNO

10.58.55-Z-ZBO

Máquina de 45 e 55 mm



MERCÚRIO

10.58.58G-Z-ZBO

Máquina de 45 e 55 mm

Disponível nas opções

⊕ Tetra e Trifecha



PALIO
2010/100-Z-ZC
Máquina 40 mm



ZBT

STRADA
10.25.26-Z-ZC
Máquina 40 E 55 mm



UNO
2010/40-Z-ZC
Máquina 40 mm



ZBT

Trinco Rolete

NOVIDADE!

Acabamentos:

BLACK

e **ROSE GOLD**



Toda linha com trinco regulável

4310TR-Z-IP

Acabamentos: IP/IE/IBT/IEP/ICOE
Máquina 55 mm

4010TR

Acabamentos: IP/IE/IBT
Máquina 55 mm



700-IE

Pivôs

Para portas de
100kg/200kg/300kg

Trinco Rolete

Toda linha com trinco regulável



4110/45TR-IP

Acabamentos: IP/IE/IBT/IEP
Máquina 45 mm

Disponível com
cilindro de 70mm

4140/45TR-IP

Acabamentos: IP/IE/IBT/IEP
Máquina de 45 mm



4150/45TR-IP

Acabamentos: IP/IE/IBT/IEP
Máquina de 45 mm

4005TR-IP Mini Trinco Rolete

Acabamentos: IP/IE/IBT/IEP





Indicadas para
áreas litorâneas



PUXADOR 700

Puxador para portas
de madeira em Aço inoxidável

Medida: 50mm x 20mm

Tamanhos disponíveis:

400mm / 600mm / 800mm

1000mm/1200mm /1500mm /2000mm



PUXADOR 690

Puxador para portas
de madeira em Aço inoxidável

Medida: 40mm x 10mm

Tamanhos disponíveis:

400mm / 600mm / 800mm

1000mm/1200mm / 1500mm

Puxadores



PU666-ZC

Acabamentos: ZC/ZCE/ZBT

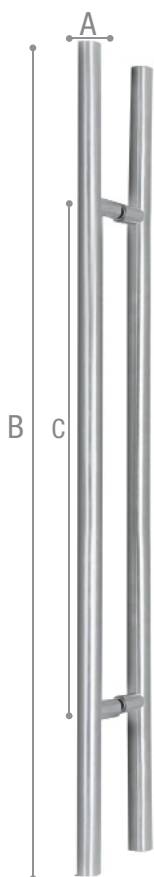

**Puxador Tubular de Inox
com opcional duplo**
Acabamentos : IE e IP

510

Larg A(POL)	Comp B(CM)	Centro C(CM)
Ø 1"	40	30
	60	40
	80	60
	100	80
	120	100
	150	130

*Outras medidas sob consulta

Fechaduras para Porta de Abrir e Correr

NOVIDADES!

Acabamentos:

ROSE GOLD

BLACK

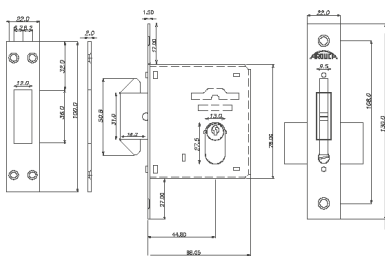

Bico Duplo 1006-Z-IP

Acabamentos: IP/IE/IBT/IEP/ICOE
Broca 45 mm

1ª Volta

2ª Volta



Acionamento completo na 2ª volta.

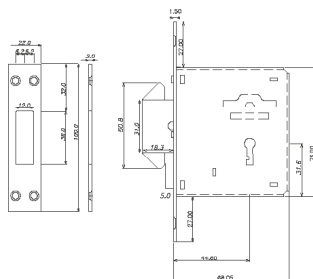

Bico Duplo 4006-IP

Acabamentos: IP/IE/IBT/IEP/ICOE
Broca 45 mm
Disponível com concha

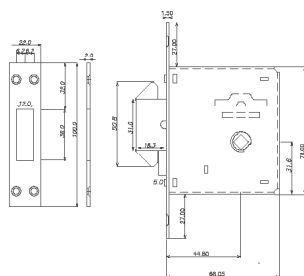

Bico Duplo 5006-IP

Acabamentos: IP/IE/IBT/IEP/ICOE
Broca 45 mm
Disponível com concha

Serralheria e Marcenaria

Fechaduras para Porta de Correr

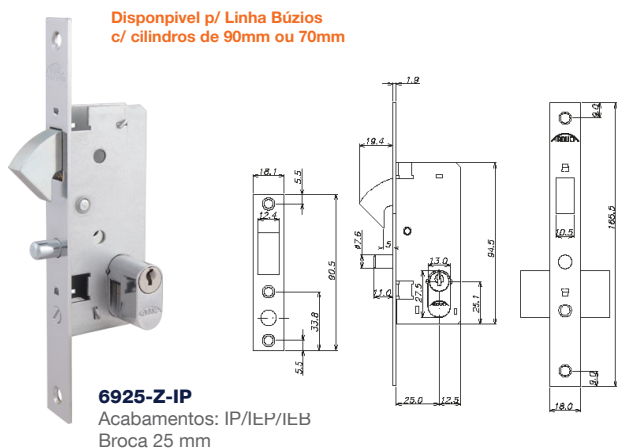
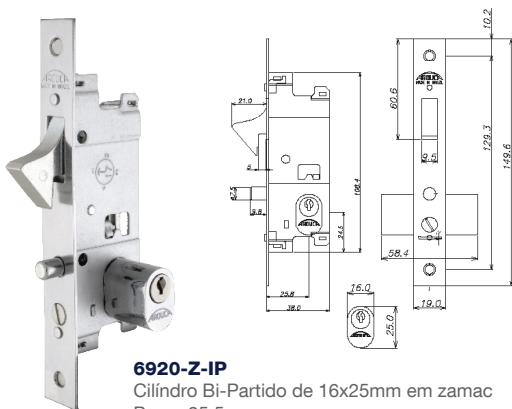

Serralheria e Marcenaria

Fechaduras para Porta de Correr

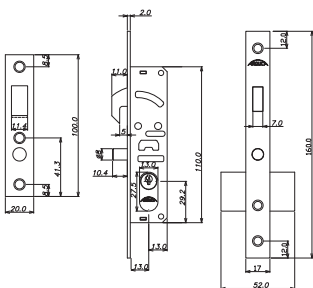

6915-Z-IP
 Acabamentos: IP/IEP/IEB
 Broca 13 mm

Indicada p/ Linha Suprema

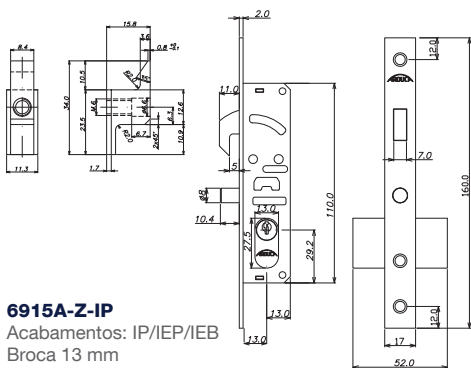

6915A-Z-IP
 Acabamentos: IP/IEP/IEB
 Broca 13 mm

Indicada p/ Linha Suprema



Disponível p/ Linha Búzios
 c/ cilindros de 90mm ou 70mm

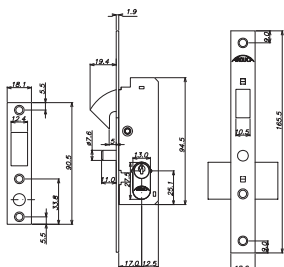

6917-Z-IP
 Acabamentos: IP/IEP/IEB
 Broca 17 mm

Indicada p/ Linha Gold

Serralheria e Marcenaria

Fechaduras para Porta de Correr

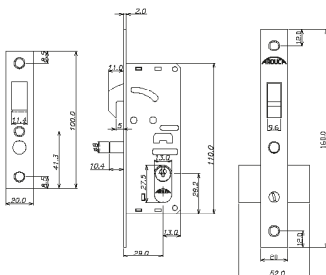
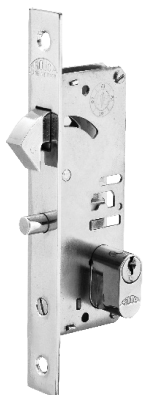

6929-Z-IP

Acabamentos: IP/IE/IBT/IEP/IEB
Broca 29mm

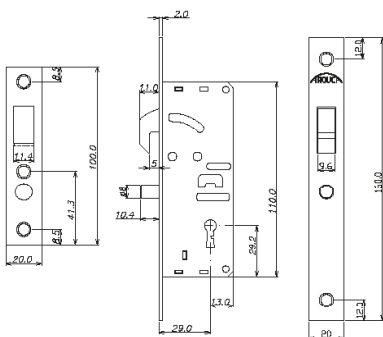

6629-IP

Acabamentos: IP/IE/IBT/IEP/IEB
Broca 29mm

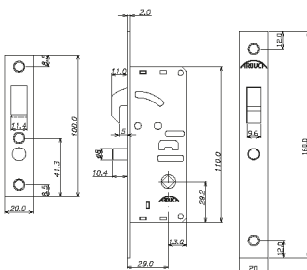

6529-IP

Acabamentos: IP/IE/IBT/IEP/IEB
Broca 29mm

Fechaduras para Porta de Correr

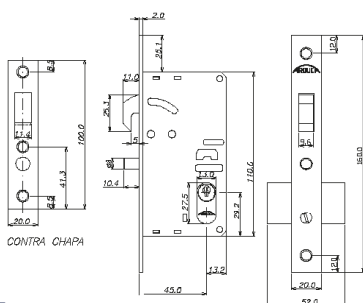

6945-Z-ir

Acabamentos: IP/IE/IBT/IEP/IEB
Broca 45mm

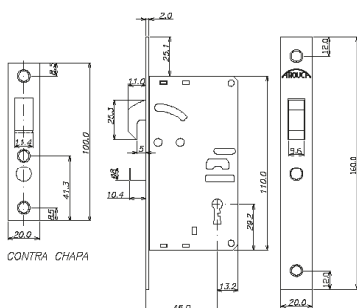

6645-IP

Acabamentos: IP/IE/IBT/IEP/IEB
Broca 45mm

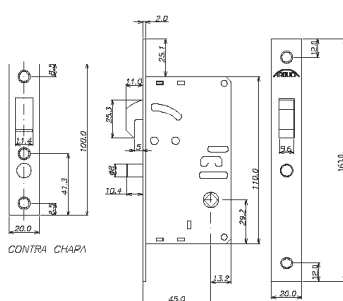

6545-IP

Acabamentos: IP/IE/IBT/IEP/IEB
Broca 45mm

Serralheria e Marcenaria

Fechaduras para Porta de Perfil Metálico

DISPONÍVEIS PARA A LINHA BÚZIOS COM
CILINDROS DE 90 OU 70 MM



PALIO

Perfil Metálico

11.09.40-Z-ZC

Acabamentos: ZC/ZEP/ZEB

Broca 20 mm



VICTORIA

Perfil Metálico

11.09.49-Z-ZEB

Acabamentos: ZC/ZEP/ZEB

Broca 20 mm



MA540-PALIO



MA549-VICTORIA



MA575-IDEA



MA559-LINEA



MA529-POLO - Z

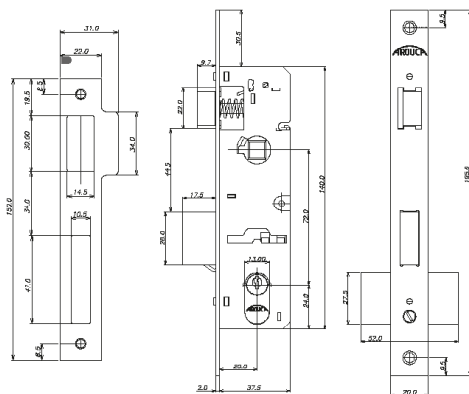

Disponível nas opções



Serralheria e Marcenaria

Fechaduras para Porta de Perfil Metálico

Novidade!

Novas fechaduras para Perfil estreito

Compatível com as principais marcas do mercado

DISPONÍVEIS PARA A LINHA BÚZIOS COM CILINDROS DE 74 OU 90 MM



160575-Z-ZC

Acabamentos
ZC/ZEP/ZEB
Broca 20 mm

OPCIONAL: ESPELHO 209

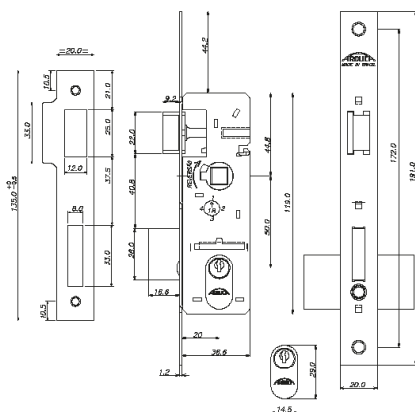

Fechaduras para Porta de Perfil Metálico



190940-Z-ZC

Acabamentos
ZC/ZEP/ZEB
Broca 29 mm
OPCIONAL: ESPELHO 205

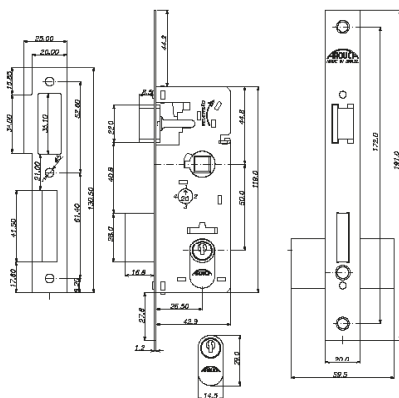

MAÇANETAS DISPONÍVEIS



MA559-LINEA



MA575-IDEA



MA537-CELTA



1/2 BOLA 1/2 ALAVANCA



MA540-PALIO



MA539-UP



MA529-POLO Z



MA549-VICTORIA

7072

TRINCO REVERSÍVEL



Pintura Epóxi no cilindro
Mais resistência a corrosão

Travas de segurança Tetrachave

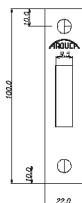
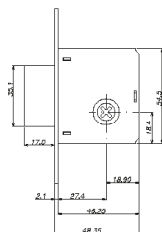
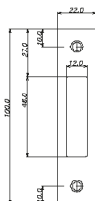

4001-IP

Acabamentos: IP/IE/IBT/IEB/IEP

DISPONÍVEL COM
OPÇÃO DUPLA (EM PAR)

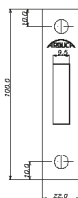
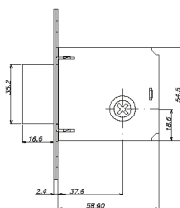
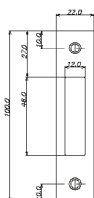

4002-IP

Acabamentos: IP/IE/IBT/IEB/IEP

DISPONÍVEL COM
OPÇÃO DUPLA (EM PAR)

Fechaduras Auxiliares

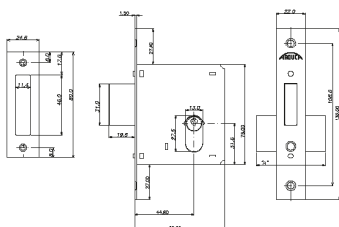

1010-Z-IP

Acabamentos: IP/IE/IBT/IEB/IEP

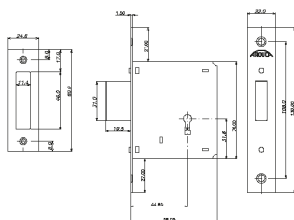

1040-IP

Acabamentos: IP/IE/IBT/IEB/IEP

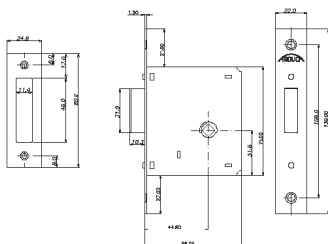

1050-IP

Acabamentos: IP/IE/IBT/IEB/IEP

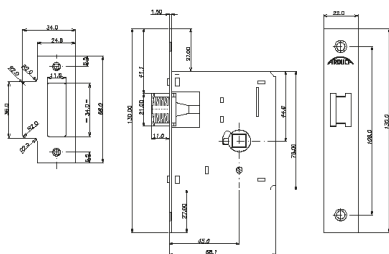

1023-IP Bate Fecha

Acabamentos: IP/IE/IBT/IEB/IEP

Fechaduras Auxiliares

NOVIDADES!

Acabamentos:

BLACK e ROSE GOLD

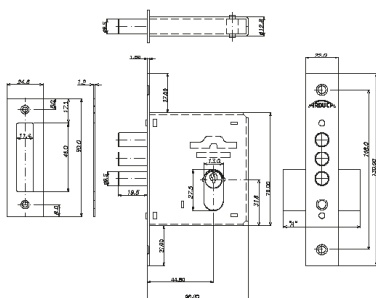

1310-Z-IP Cilindro Monobloco

Acabamentos: IP/IE/IBT/IEB/IEP/ICOE
Broca 45mm

Fechaduras Auxiliar Para Perfil Metálico

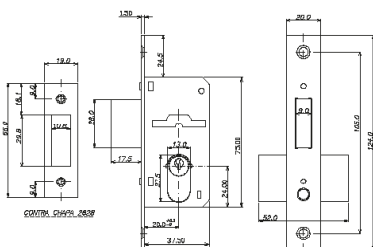

1132-Z-IP

Acabamentos: IP/IEB/IEP
Broca 20mm

Fechadura Auxiliar de sobrepôr



TR7474 - Z - FEP

Dobradiças Vai e Vem

403-FC
Para portas com
peso de até 25 Kg
Acabamentos
FC/FEP



404-FEP
Para portas com
peso até 35 Kg
Acabamentos FC/FEP

Acessórios

Conchas



1290 S/F-LC



1288 I-LC



1284I-LC

ACABAMENTOS
LC/LCE/LBT

Tarjetas

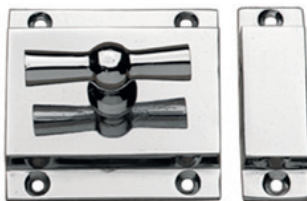

1515/136-ZC
Tarjeta Livre-Ocupado

Máquinas



4010/55

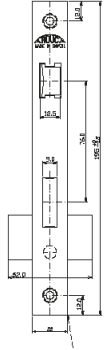
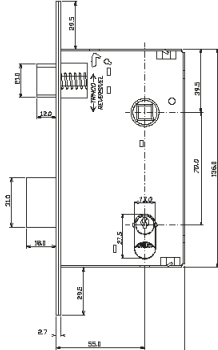
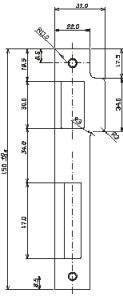

NOTA: DISPONÍVEIS TAMBÉM COM CANTOS REDONDOS

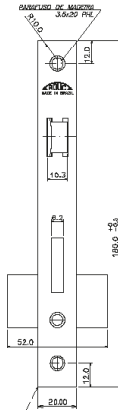
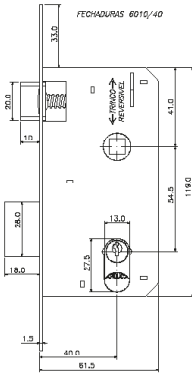
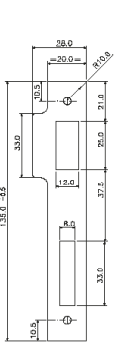

NOTA: DISPONÍVEIS TAMBÉM COM CANTOS REDONDOS

6010/40

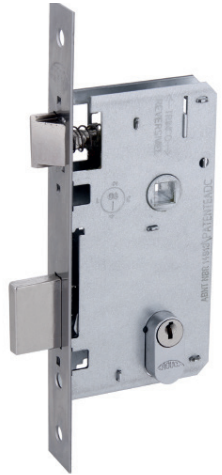

Cilindros

CILINDRO DE REPOSIÇÃO

Reposição: STAM
Linha 500/ 600/ 800/ 900

CL2011ST



Cilindro oval bi-partido
Acabamentos:
ZC/ZEP/ZEB

CÓDIGO	COMPRIMENTO
CL2011ST	52mm
CL2011/74ST	74mm
CL2011/90ST	90mm

Novo cilindro **MONOBLOCO**

INDICADOS PARA AS LINHAS:

com 110mm!

Residenciais, Trinco Rolete,
Auxiliares, Perfil Metálico e
Serralheria e Marcenaria

Cilindro monobloco oval
Acabamentos ZC/ZEP



CÓDIGO	COMPRIMENTO	ESPESSURA DA PORTA
CL2010-Z	52mm	Até 35mm
CL2010/60-Z	60mm	35mm a 45mm
CL2010/70-Z	70mm	45mm a 55mm
CL2010/90-Z	90mm	55mm a 75mm
CL2010/110-Z	110mm	Até 100mm

Cilindro em **ZAMAC**



CL45-Z

Cilindro redondo bi partido
Acabamentos:
ZC/ZEP

Mostruários

Display 02 palhetas



Totem de ferro giratório



Display 03 palhetas



Totem de madeira fixo



Cepo tipo balcão



Cepo bandeira





DESDE 1938



ISO 9001:2015

A injeção de peças técnicas Arouca é certificada pela ISO 9001.



PBQP-H

A Arouca é certificada pelo Programa Brasileiro de Qualidade e Produtividade do Habitat Programa do Governo Federal que tem como meta elevar os patamares da qualidade da Construção Civil.



**ASSOCIAÇÃO
BRASILEIRA
DE NORMAS
TÉCNICAS**

ABNT NORMAS

As fechaduras Arouca são produzidas e testadas conforme todos os requisitos das normas da ABNT.



MATERIA-PRIMA DE QUALIDADE

Todos os produtos Arouca utilizam matéria-prima da mais alta qualidade, com total rastreabilidade.



10 ANOS DE GARANTIA:

Fechaduras com 10 anos de garantia de funcionamento.



Os produtos Arouca são genuinamente nacionais e idealizados para atender plenamente consumidores que buscam elegância, praticidade e segurança.

NORMA NBR 14913



Produtos produzidos de acordo com a NBR 14913

● GRAU DE SEGURANÇA

GRAU DE SEGURANÇA	UTILIZAÇÃO	RESISTÊNCIA
MÁXIMA	INT/EXT/WC	10kN
MUITO ALTA	INT/EXT/WC	7kN
ALTA	INT/EXT/WC	5kN
MÉDIA	INT/EXT/WC	3kN
MÍNIMA	INT//WC	2kN

● RESISTÊNCIA A CORROSÃO

GRAU	CONDIÇÕES DO AMBIENTE	TEMPO DE EXPOSIÇÃO EM SALT SPRAY
4	Com condições severas quanto à umidade e intempéries EX: regiões litorâneas	144 Hs
3	Com umidade e intempéries EX: áreas externas urbanas e rurais	72 Hs
2	Com umidade e sem intempéries EX: cozinhas e banheiros	48 Hs
1	Sem umidade e sem intempéries EX: salas e dormitórios	24 Hs

● FREQUÊNCIA DE USO

	TRÁFEGO		
	INTENSO	MÉDIO	LEVE
Funcionamento da lingueta pela chave	120.000	75.000	35.000
Funcionamento do trinco pela maçaneta	600.000	300.000	100.000
Funcionamento do trinco por ataque lateral	600.000	300.000	100.000
Introdução e retirada de chave	120.000	75.000	35.000
Utilização da fechadura	Residenciais, consultórios, escritórios, hospitais, shopping center, etc	Residências, consultórios, escritórios, etc	Residências, comunicação entre cômodos, etc